

DATA SHEET

4D/IMG AUTOMOTIVE RADAR SENSOR

DRVEGRD[®] 166



s.m.s, smart microwave sensors GmbH
In den Waashainen 1
38108 Braunschweig
Germany

Phone: +49 531 39023-0
Fax: +49 531 39023-599
info@smartmicro.de
www.smartmicro.com

CONTENT

1	User Safety Warning.....	3
2	Sensor Specifications.....	5
2.1	Measurement Principle	5
2.2	Sensor Beams	8
2.3	Sensor Dimensions	13
2.4	Sensor Connector	14
2.5	Sensor and Hardware Identification	15
3	General Performance Data.....	16
3.1	Self-Diagnosis	18
3.2	Sensor Network.....	18
3.3	Ethernet Connection	20
4	Application-Specific Characteristics	21
4.1	Point Cloud.....	22
4.2	Radar Cube Streaming	22
5	Compliances.....	23
6	Legal Disclaimer Notice	24

1 USER SAFETY WARNING

Please read the entire document carefully before using the sensor.

INSTALLATION

Please pay attention to the details below before installing and connecting the sensor:

- Only use provided or approved equipment for the installation.
- Only skilled and instructed persons shall install and connect the sensor. Proper experience in working with mains voltage, electrical and electronic devices is required.
- Do not connect the sensor directly to the mains voltage; instead use the voltage specified for the product.
- Do not wire any connections when power is applied to the device.
- Ground devices carefully to prevent electrical shock.
- All connectors are pin-coded and fit in only one position. Also note the arrow indicating the top side of the sensor.
- Only use fully functional equipment (ladders, aerial work platform, etc.) when working above ground. Staff shall be capable of working at heights.
- Be cautious when installing the sensor on or around active roadways and pay attention to moving traffic.
- Mount the sensor carefully to prevent it from shifting or dropping.
- The sensor must be mounted to a stiff bracket on the vehicle. Vibration, oscillation or other movement will reduce the sensor performance.
- Make sure that installation methods are in accordance with local safety policies and procedures as well as company practices.

OPERATION

Do not operate the sensor if the device itself or any cables are damaged.

Transmission of radio frequency waves starts after the sensor is powered up and stops when it is disconnected from power.

For testing purposes, the sensor may be laid on its face when it is powered up, given that the surface or connectors will not be damaged this way. Please note that this position is not intended for permanent use.



The sensor may become hot during operation. Proper hand protection is recommended for maintenance work.



Do not dispose electrical and electronic equipment in household trash.

TECHNICAL SERVICE

Only use provided or approved equipment for operation. People other than authorized and approved electrical technicians shall NOT attempt to connect the device to a power supply or other controllers, as there is a risk of electrical shock by unsafe handling of the power source.

Do not attempt to service or repair this device:

- No user-maintainable parts are contained in the device.
- To avoid electrical shock, do not remove or open the cover.
- Unauthorized opening will void all warranties.
- smartmicro is not liable for any damages or harms caused by unauthorized attempts to open or repair the device.

RADIATION

Operation is subject to the following two conditions:

- This device may not cause harmful interference.
- This device must accept any interference received, including interference that may cause undesired operation.

This device generates radio frequency energy. There are strict limits on continuous emission power levels to provide reasonable protection against harmful interference when the equipment is operated in a commercial environment.

- Human exposure to transmitted waves from this device is generally considered as safe. Still, it is considered good practice that humans are not subject to higher radiation levels than necessary.

This device may interfere with other devices using the same frequency band.

2 SENSOR SPECIFICATIONS

DRVEGRD 166 is a 76-77GHz radar sensor for multiple automotive and industrial applications that features 4D/IMG (imaging radar) technology.

The sensor's antenna aims at long range and wide horizontal angular coverage. With the combination of its 12 TX and 16 RX antennas, forming a 192 virtual TRX antenna array, the sensor can achieve a high angular resolution. The sensor has multiple modes of operation:

- A Long-Range -Mode for up to 300m (984.25ft) range
- A Medium-Range-Mode for up to 132m (433.1ft) range
- A Short-Range-Mode for up to 88m (288.7ft) range
- An Ultra-Short-Range-Mode for up to 42m (137.8ft) range

2.1 MEASUREMENT PRINCIPLE

Using a patented transmit waveform, the sensor measures range, radial speed, azimuth and elevation angle, reflectivity, and more parameters of multiple stationary and moving reflectors (targets) simultaneously. It is capable of imaging-high definition (4D/IMG), where IMG resolution means that the sensor features imaging resolution (separation) in four parameters: range, Doppler, azimuth and elevation angle.

The sensor is almost unaffected by weather, temperature, and lighting conditions. It withstands high shock and vibration levels, is maintenance free and made for a long lifetime.

smartmicro radars employ a patented A/B fast chirp-sequence frequency-modulated continuous wave (A/B CS-FMCW) modulation.

FMCW radars can natively separate targets in two dimensions: Range and speed. Transmitting, receiving, and processing a single linear frequency ramp (chirp) enables the radar to detect and separate multiple targets within the radar's field of view.

CS-FMCW radars use multiple chirps as part of one measurement (one radar cycle). The results from multiple chirp range measurements are coherently processed, allowing the radar to measure the Doppler frequency of a target over the measurement time (typically in the order of 10-40ms). High-speed, slow speed and even stationary targets are detected by the smartmicro radar.

smartmicro's patented A/B CS-FMCW technology then allows for direct unambiguous Doppler measurement (covering the complete specified speed interval) in one single measurement cycle.

The patented waveform and the high-performance signal processing allow to precisely measure the range and the speed of any target and even allow resolving multiple targets that are at the same range from the radar but traveling at different radial velocities or vice versa.

smartmicro radars employ multiple transmit, and receive antennas, adding a spatial component to the measurement process. In addition to range and speed, smartmicro 4D radars can measure the direction of any target separately in Azimuth (horizontal) and Elevation (vertical) angles.

4D/IMG MEASUREMENT

A 4D Doppler based radial motion detection principle is integrated:

- a) Direct unambiguous Doppler measurement (speed)
- b) Direct range measurement
- c) Direct azimuth angle measurement (horizontal angle)
- d) Direct elevation angle measurement (vertical angle)

Moving reflectors can be detected as well as stationary reflectors.

With its multi-target capability, the sensor can *detect* many reflectors within the field of view at a time (target list = point cloud). Additionally, optional filter algorithms are implemented for certain applications for the tracking of all detected reflectors over time. Those tracking algorithms are integrated in the sensor. Multiple objects can be *tracked* simultaneously. Please note that tracking algorithms are mode-specific and may not be available for all modes.

The result of tracking is an object list with the following parameters:

- X-position
- Y-position
- Absolute velocity
- Heading angle
- Length
- Object ID and more

In addition, status and diagnose data from the sensor are reported. The sensor reports such a list of all tracked objects in every measurement cycle of typically ≤ 50 ms length. Based on all detected targets and tracked objects within the field of view, an application algorithm, such as adaptive cruise control or collision warning, may be implemented.

4D/IMG RESOLUTION - OBJECT SEPARATION PERFORMANCE

The sensor divides the field of view into range gates and azimuth angular beam positions and performs a Doppler (speed) measurement separate for each individual range and angular gate.

Individual reflectors are separated by detection algorithms if having either:

- A different radial speed value or
- A different range value or
- A different azimuth angular position or
- A different elevation angular position.

USER CONFIGURABILITY

The operational mode and frequency band are user-configurable:

The sensor allows to switch between range modes. The modes differ regarding the waveform and the detection performance. The maximum range of all modes is at boresight.

Predefined frequency bands are available for user configuration.

2.2 SENSOR BEAMS

The sensor can be used for applications like Adaptive Cruise Control (ACC) and Automatic Emergency Braking (AEB) applications.

The sensor is equipped with an Ultra-Short-Range Mode, a Short-Range Mode, a Medium-Range Mode and a Long-Range Mode.

Multiple non-overlapping frequency bands are available to reliably avoid mutual interference. Four frequency bands are available for Long-Range Mode, two for Medium-Range Mode and one for Short- and Ultra-Short-Range Mode.

The following sensitivity plots demonstrate the field of view in which a radar reflector with a given radar cross section is detected. The detection probability at the limit of detection is 50%.

The radar features detection at high range with a more focused beam - FAR processing - as well as wide field of view for close range - NEAR processing. Each mode (Long-, Medium-, Short- and Ultra-Short-Range Mode) applies a FAR and a NEAR processing. FAR and NEAR scans run simultaneously in one radar cycle. The resulting detection zone is the envelope of the FAR and NEAR zone for the respective mode.

Application specific parameter sets may narrow the field of view.

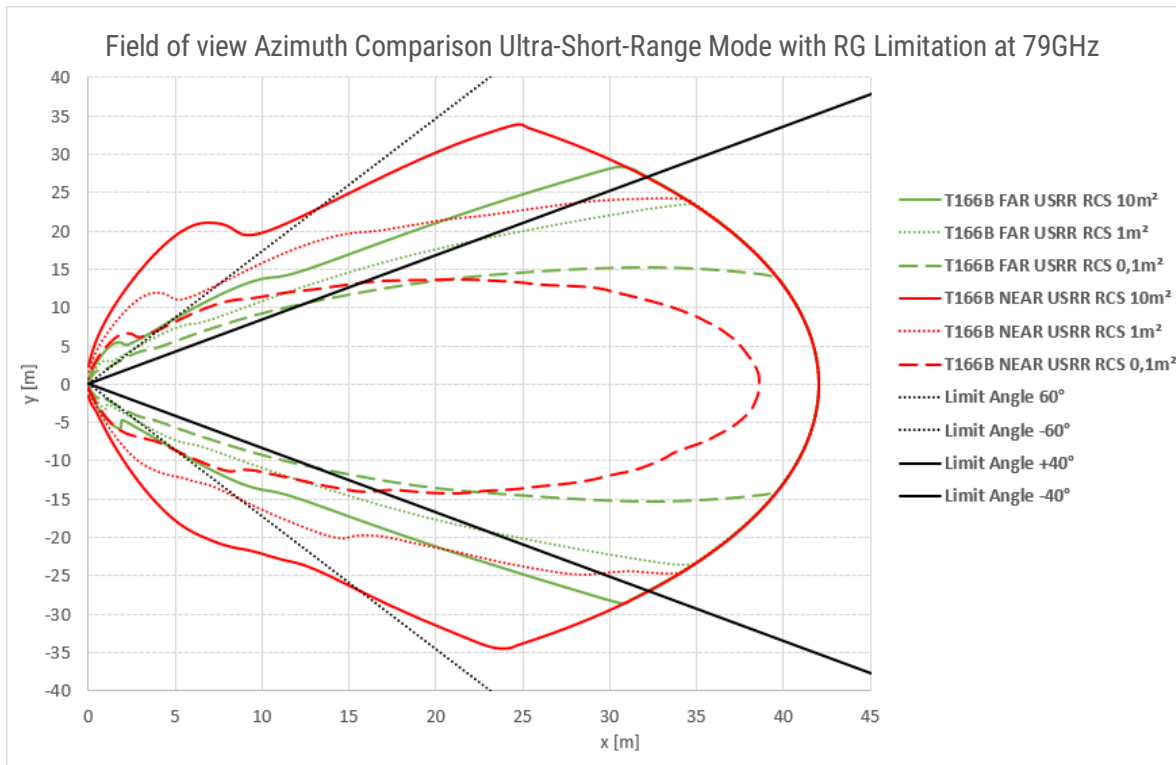

Figure 1: Field of view Azimuth Plot Ultra-Short-Range Mode

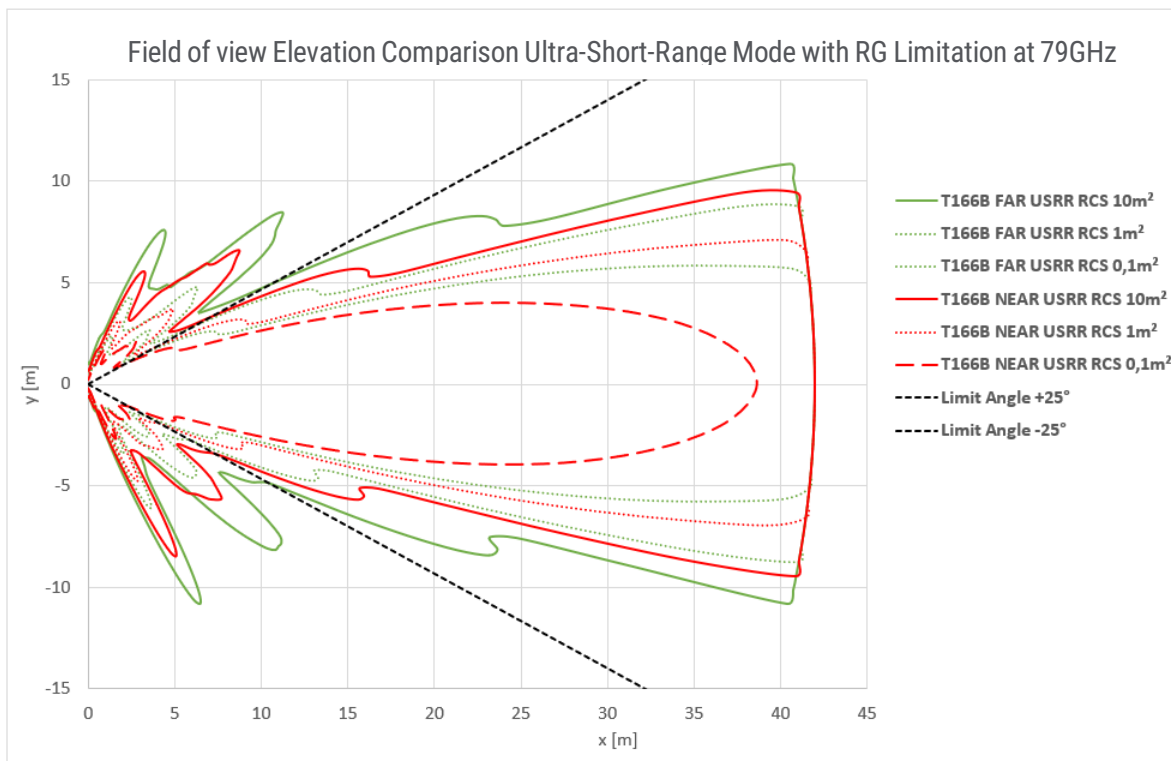

Figure 2: Field of view Elevation Plot Ultra-Short-Range Mode

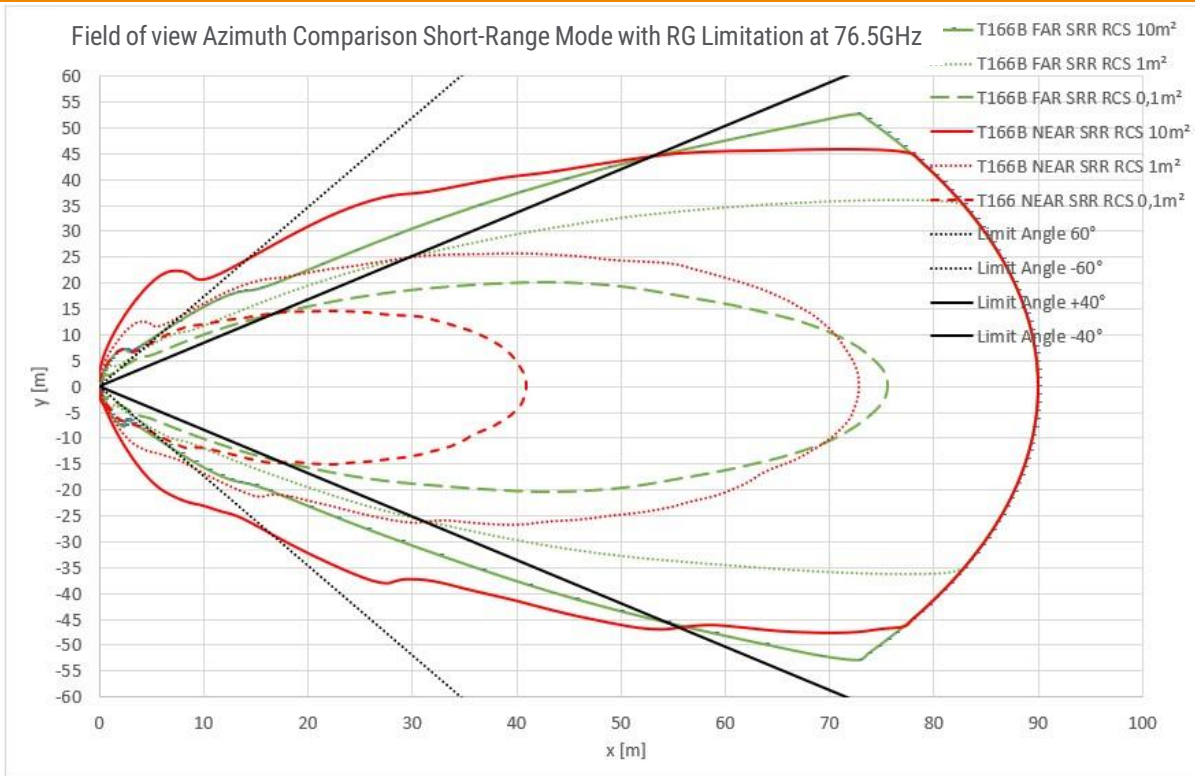

Figure 3: Field of view Azimuth Plot Short-Range Mode

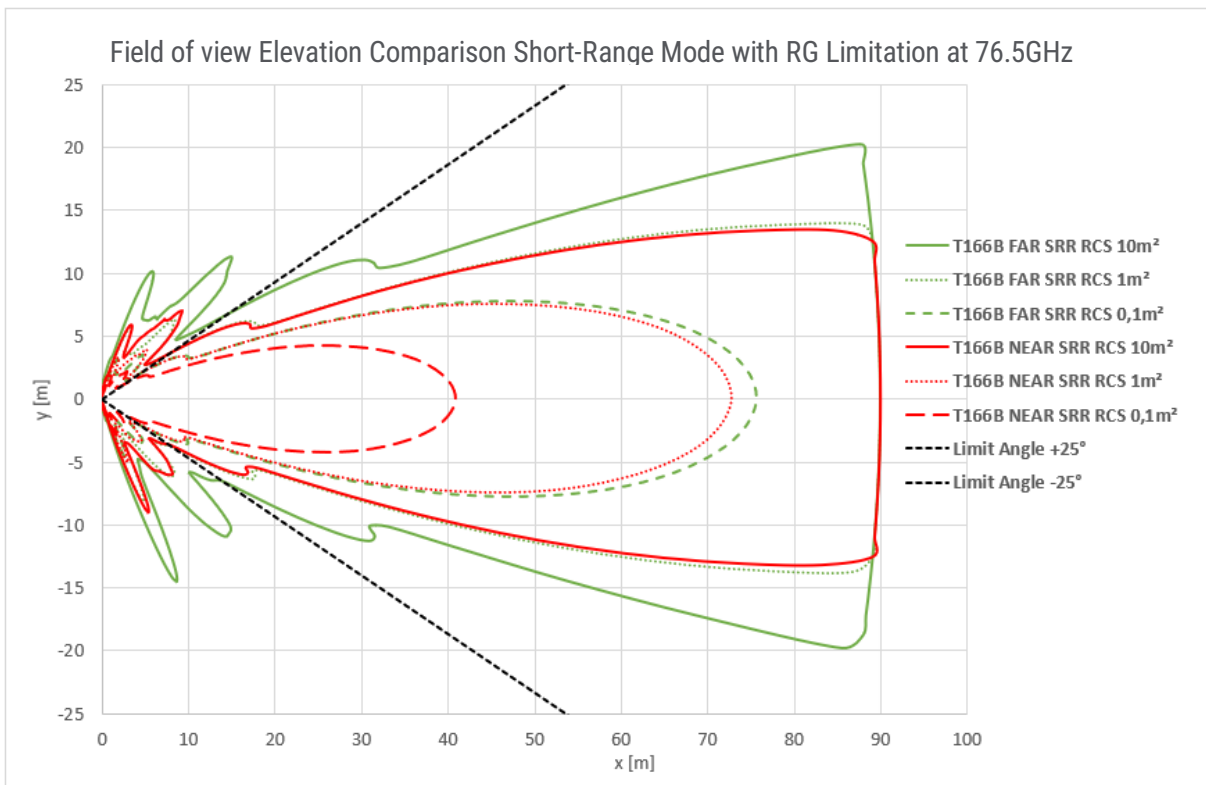

Figure 4: Field of view Elevation Plot Short-Range Mode

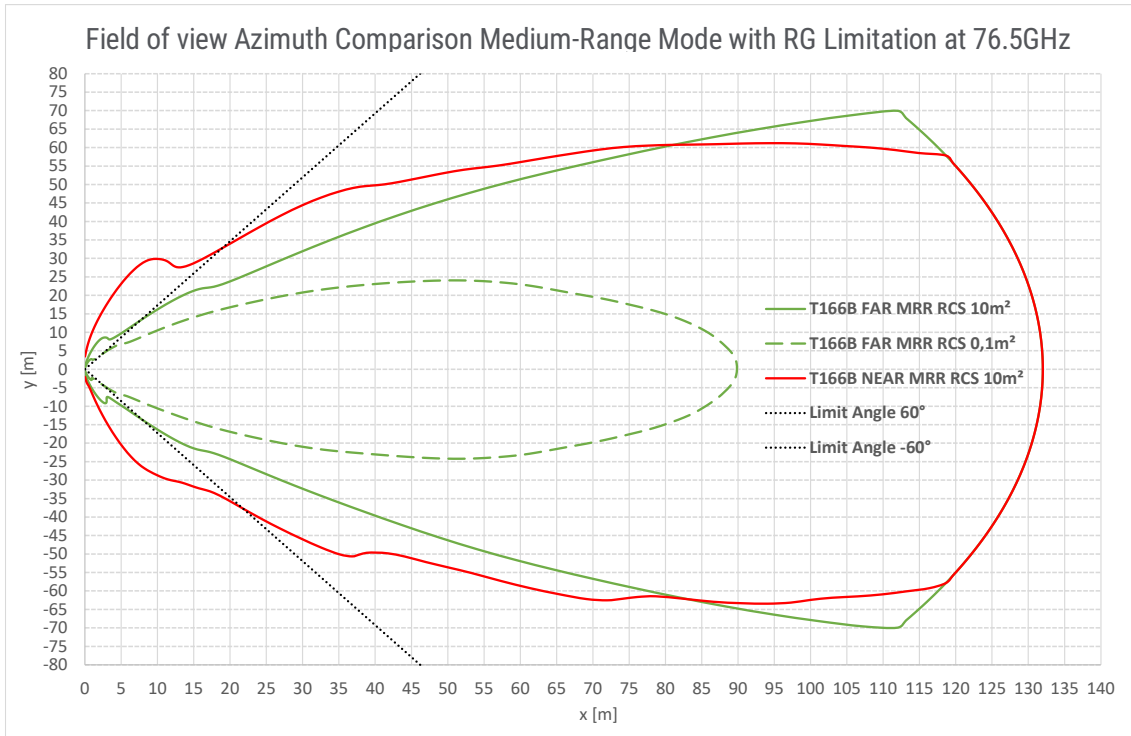

Figure 5: Field of view Azimuth Plot Medium-Range Mode

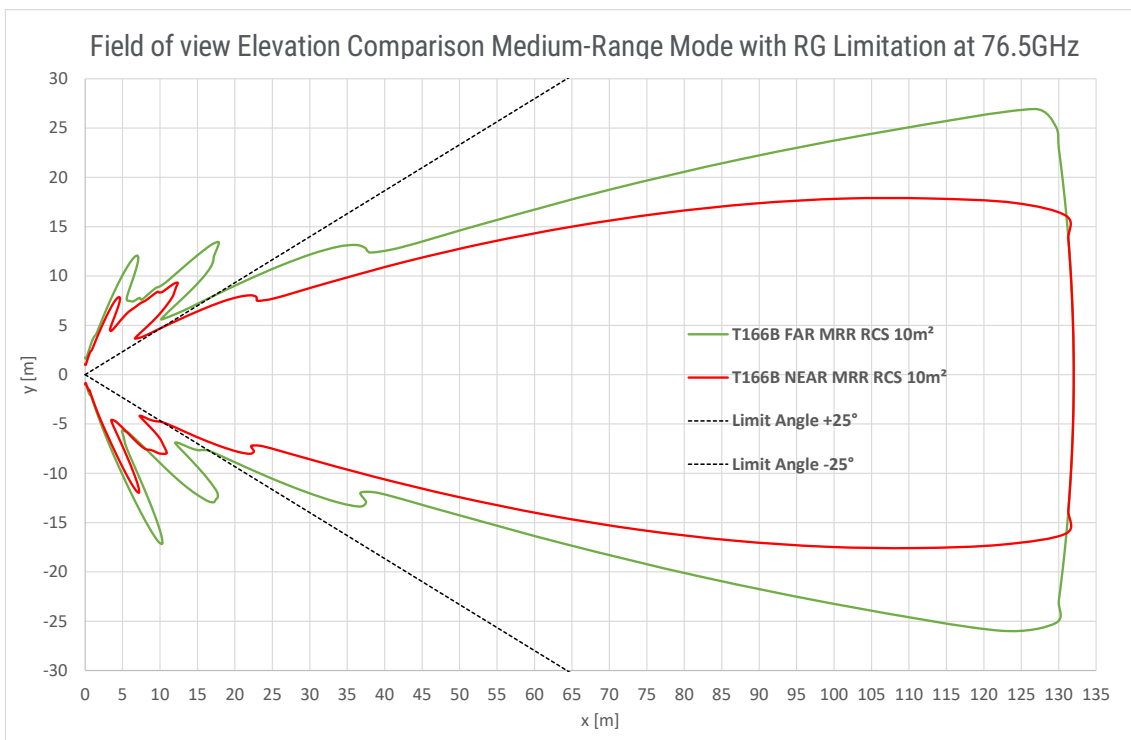

Figure 6: Field of view Elevation Plot Medium-Range Mode

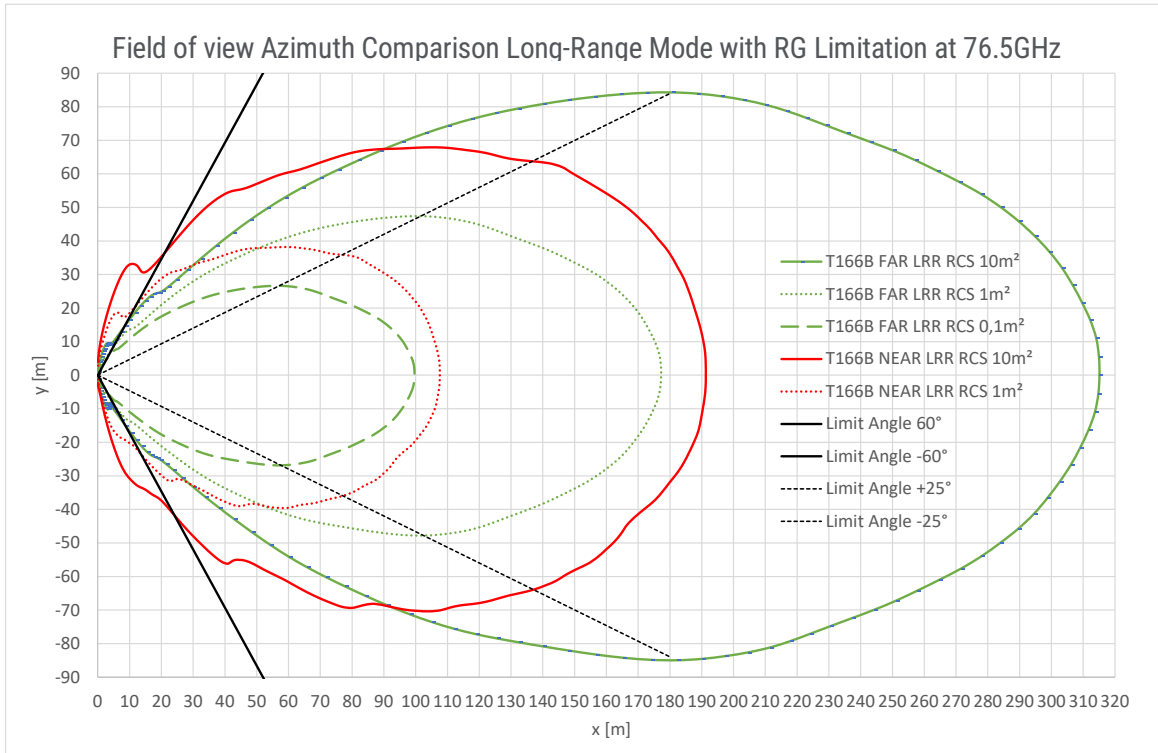

Figure 7: Field of view Azimuth Plot Long-Range Mode

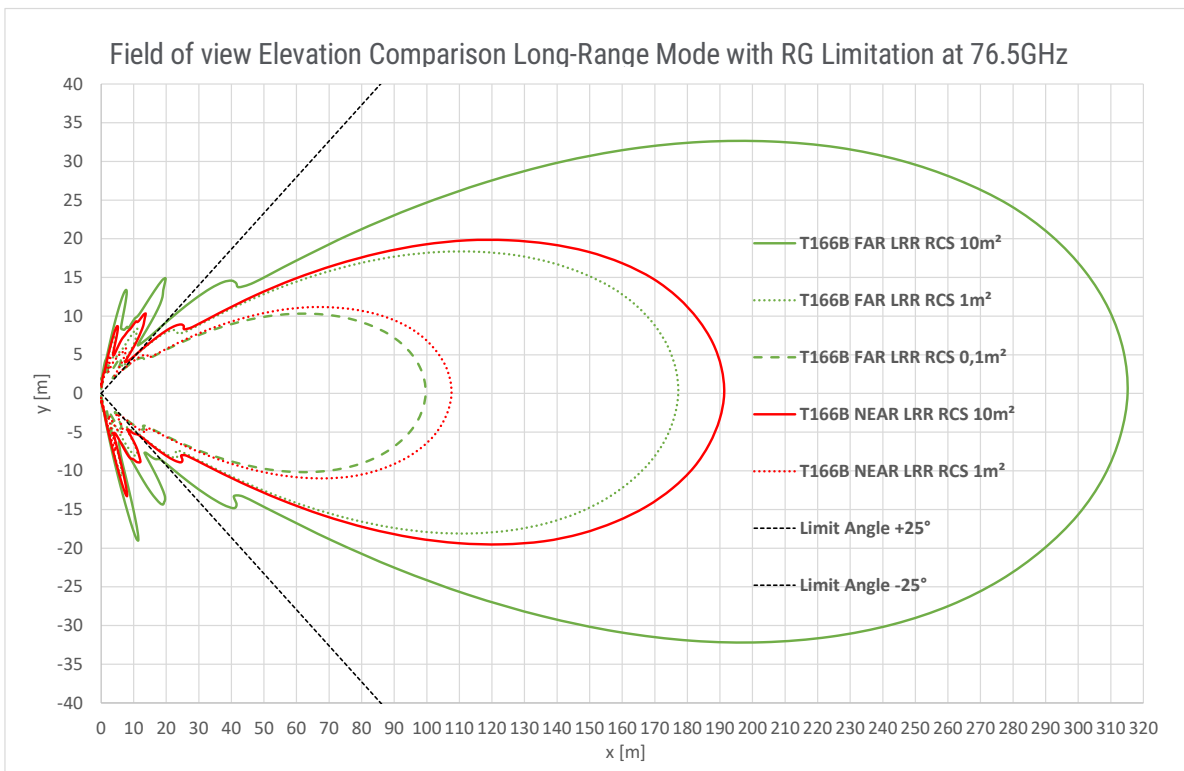
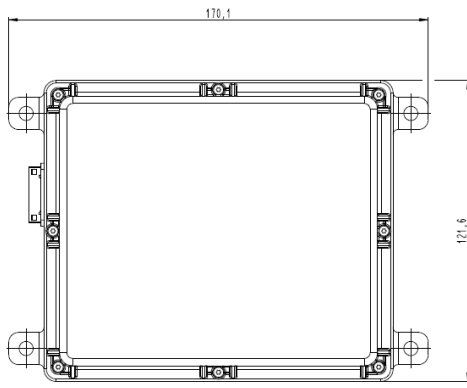

Figure 8: Field of view Elevation Plot Long-Range Mode

2.3 SENSOR DIMENSIONS

All values are given in mm.



Sensor Front Side

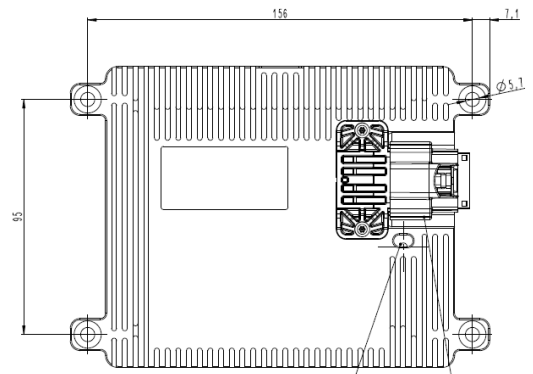
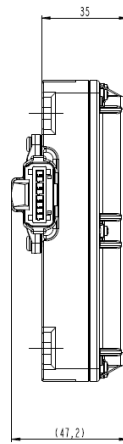

Sensor Rear Side

2.4 SENSOR CONNECTOR

The sensor connector is a 8-pin male (plug) connector (waterproof IP67, MX64 Molex Series 31404). A female counterpart (socket), Molex 64 series 31404, must be used to connect with the sensor.

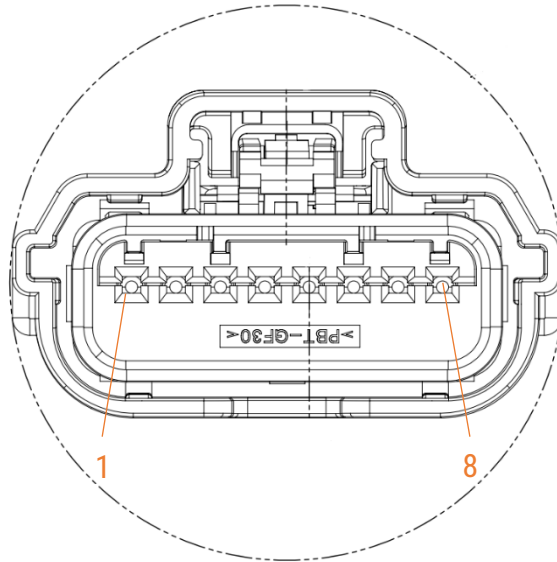

*View on solder cup side of socket showing the pin numbering
(rear view of female counterpart to be connected to sensor)*

Sensor connector pin out:

Pin No.	Cable Connector
1	V_Supply
2	GND
3	Auto_Eth_TX_N
4	Auto_Eth_TX_P
5	CAN1_N
6	CAN1_P
7	CAN0_N
8	CAN0_P

Please note that in the standard configuration the sensor does have a 120 Ohms resistor on board for CAN1 (CAN bus termination between CAN L and CAN H). This resistor is required at either end of a CAN bus. CAN0 has high impedance termination (2.6 kOhm).

Several cable sets for initial operation and test purposes are offered by smartmicro, to deliver a fast set-up of a sensor system. Among those preconfigured ready-to-run cables as well as cable stumps (pig tail cables or various lengths) which carry the connector on one side and open wires on the other.

2.5 SENSOR AND HARDWARE IDENTIFICATION

The sensor housing is tagged with a type sticker containing the product description and the serial number. It also indicates which side of the sensor is the top side.

Sticker example:

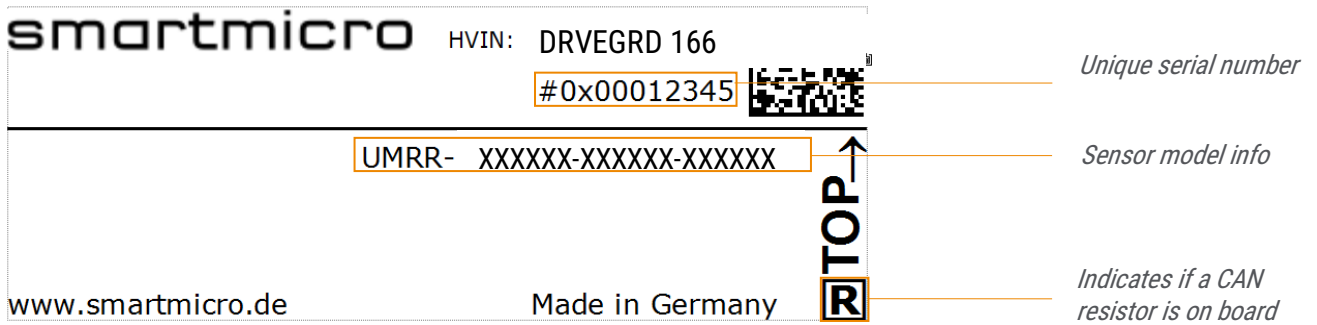

Additionally, the DSP board and the RF board have their own unique serial numbers.

3 GENERAL PERFORMANCE DATA

Parameter	Long-Range Mode	Medium-Range Mode	Short-Range Mode	Ultra-Short-Range Mode ¹
Operating Frequency	76...77GHz	76...77GHz	76...77GHz	76-81GHz
Center Freq. (Bands) ²	4	2	1	1
Range Min./Max. ³	1.8m/300m	0.5m/132m	0.32m/88m	0.16m/42m
	5.9ft/984.3ft	1.6ft/433.1ft	1.1ft/288.7ft	0.5ft/137.8ft
Separation	≤ 2.5m ≤ 8.2ft	≤ 0.55m ≤ 1.8ft	≤ 0.42m ≤ 1.4ft	≤ 0.23m ≤ 0.8ft
Sensitivity on Passenger Car ⁴	250m 820.2ft	132m 433.1ft	88m 288.7ft	42m 137.8ft
Accuracy ⁵	< 0.75m < 2.5ft	< 0.17m < 0.6ft	< 0.1m < 0.3ft	< 0.05m < 0.2ft
Speed Min./Max.	-400...+200km/h	-400...+200km/h	-180...+180km/h	-126...+126km/h
	-249...+124mph	-249...+124mph	-111...+111mph	-78...+78mph
Separation	≤ 0.15m/s	≤ 0.15m/s	≤ 0.15m/s	≤ 0.15m/s
Accuracy ⁶	< 0.04m/s	< 0.04m/s	< 0.04m/s	< 0.04m/s
Angle Field of View: Azimuth ⁷	-50...+50°	-50...+50°	-50...+50°	-55...+55°
	-10...+10°	-10...+10°	-10...+10°	-12.5...+12.5°
Field of View: Elevation ⁸	-10...+10°	-10...+10°	-10...+10°	-12.5...+12.5°
Separation: Azimuth ⁹	1°	2°	2°	2°
Separation: Elevation ¹⁰	2°	1°	1°	1°
Accuracy: Azimuth ¹¹	≤ 0.25°	≤ 0.25°	≤ 0.25°	≤ 0.25°
Accuracy: Elevation ¹²	≤ 0.25°	≤ 0.25°	≤ 0.25°	≤ 0.25°
Mechanical Details				
Weight	< 830g < 30.3oz			
Dimensions (H/W/D)	122 x 171 x 48mm 4.8 x 6.7 x 1.9in			

¹ Not available yet.

² Can be selected at runtime.

³ Typical values; all values given for bore sight; they may vary depending on the clutter environment. Please note that the radar system can neither achieve a detection probability of 100% nor a false alarm rate equal to zero.

⁴ Typical value for 10dBm² reflector at slow/medium speed; may vary to higher or lower values depending on clutter environment, at bore sight. Reduced for high-speed targets.

⁵ Measured on point reflector having zero radial speed, at bore sight.

⁶ Measured on point reflector having constant radial speed, at bore sight.

⁷ The total field of view is an angle interval in which reflectors can be detected; 3dB field of view is narrower.

⁸ The total field of view is an angle interval in which reflectors can be detected; 3dB field of view is narrower.

⁹ Measured for two point reflectors at bore sight with >25dB S/N. Falls off toward larger absolute angles, not available with final performance yet.

¹⁰ Measured for two point reflectors at bore sight with >25dB S/N. Falls off toward larger absolute angles, not available with final performance yet.

¹¹ Typical value; measured at target output level at bore sight, for a point reflector showing >25dB SNR. Error may increase towards larger angles, typically 0.25° at |AZ| < 20°, 0.5° at 20° ≤ |AZ| < 40°, 1.0° at 40° ≤ |AZ|. In addition to this angle error, due to RFIC characteristics, angle may have an offset which changes over temperature (-40...+85°C), typically -0.25deg to +0.25deg over specified operation temperature interval.

¹² Typical value; measured at target output level at bore sight, for a point reflector showing >25dB SNR. Error may increase towards larger angles, typically 0.25° at |EL| < 8°, 0.5° at 8° ≤ |EL| < 12°, 1.0° at 12° ≤ |EL|. In addition to this angle error, due to RFIC characteristics, angle may have an offset which changes over temperature (-40...+85°C), typically -0.5deg to +0.5deg over specified operation temperature interval.

Further Information	
Initialization Time	< 15s
Update Cycle Time ¹³	≤ 55ms
Processing Latency	2-4 cycles
Operating Voltage ¹⁴	7...32V
Point Cloud Rate	up to 1024 per cycle (20.480 points per second)
Power Consumption ¹⁵	<15W
Bandwidth ¹⁶	< 1000MHz
Max. Transmit Power (EIRP)	< 35dBm
Operating & Storage Temperature	-40...+85°C -40...+185°F
Interfaces ¹⁷	2xCAN FD 5Mbit/s Ethernet 100MBit (2-wire) [default]; Ethernet 1Gbit (2-wire) [radar cube streaming]
Connector	MX64 Molex Series
Shock / Vibration ¹⁸	10g _{rms} / 14g _{rms}
Relative Humidity	0...95% (non-condensing)
IP	67
Pressure or Transport Altitude	0...10000m 0...32800ft

¹³ Target value; may be longer depending on the number of detected radar targets. Currently ~100ms.

¹⁴ Measured at the connector.

¹⁵ Depending on supply voltage and temperature; Power consumption decreases with lower voltage and lower temperature.

¹⁶ Ultra-Short-Range Mode has higher bandwidth: <2GHz.

¹⁷ It is recommended to use an external surge protection for power, CAN, Ethernet and other interface ports. CAN and CAN FD not yet available.

¹⁸ Not available yet.

START-UP TIME

After powering up or resetting, sensor readings meet the specified performance in < 15 seconds.

3.1 SELF-DIAGNOSIS

The sensor cyclically reports a status message providing its cycle time, run time and diagnosis information. Additionally, the sensor can also provide sensor mode and status information on request.

The diagnosis information provided by the sensor is an optional self-diagnosis feature to allow limited fail-safe capabilities, which helps in detecting for example:

- Sensor blindness¹⁹
- Detection and automatic suppression of RF interference, or rather signals from other radar sensors operating in the same frequency band.

3.2 SENSOR NETWORK

Sensors are typically used standalone. However, for one vehicle multiple sensors can be connected to one sensor fusion ECU. Such networks are possible by using the CAN(FD) or Automotive Ethernet interface. All sensors in the network can work on a plug-and-play basis after the configuration of separate frequency channels, which avoid mutual interference. Customer-specific configurations are possible.

DATA LOGGING AND VISUALIZATION TOOLS

Drive Recorder

The visualization of all data (target lists, object lists, etc.) is possible using the Drive Recorder software on a Windows PC. It also provides for example data logging, associated video documentation, play back and analysis functions.

ROS

smartmicro offers Robot Operating System (ROS) support which includes ROS drivers for ROS1/ROS2 environments for easier customer integration of the sensors and ready-to-run real-time visualization using ROS display tools. The proprietary radar protocol can be read into ROS, which facilitates the processing and visualization of radar data.

¹⁹ Not available yet.

Smart Access

In alternative to the provided Drive Recorder or ROS-based solutions, the customer can also develop own software products to interface smartmicro products. For these customer applications, smartmicro provides detailed documentation on topics like the integration of the radar system interface, dbc files or example code (in C). Additionally, smartmicro provides an API developed in-house for easier communication between customer solutions and smartmicro products via Automotive Ethernet or CAN/CAN(FD).

3.3 ETHERNET CONNECTION

The sensor supports UDP via Ethernet in a Local Area Network (LAN). Communication over low bandwidth environments (not less than 100Mbps recommended) or routed networks such as the world wide web are not supported.

Features:

- Ethernet standards IPv4, ARP, IGMP IP multicast²⁰ and UDP
- Support of Static IP configuration. DHCP is not supported
- smartmicro's proprietary communication protocol "smartmicro transport protocol" with sensor data transmission, which sends a list of detected targets every radar cycle. Operation parameters can be accessed via Ethernet.

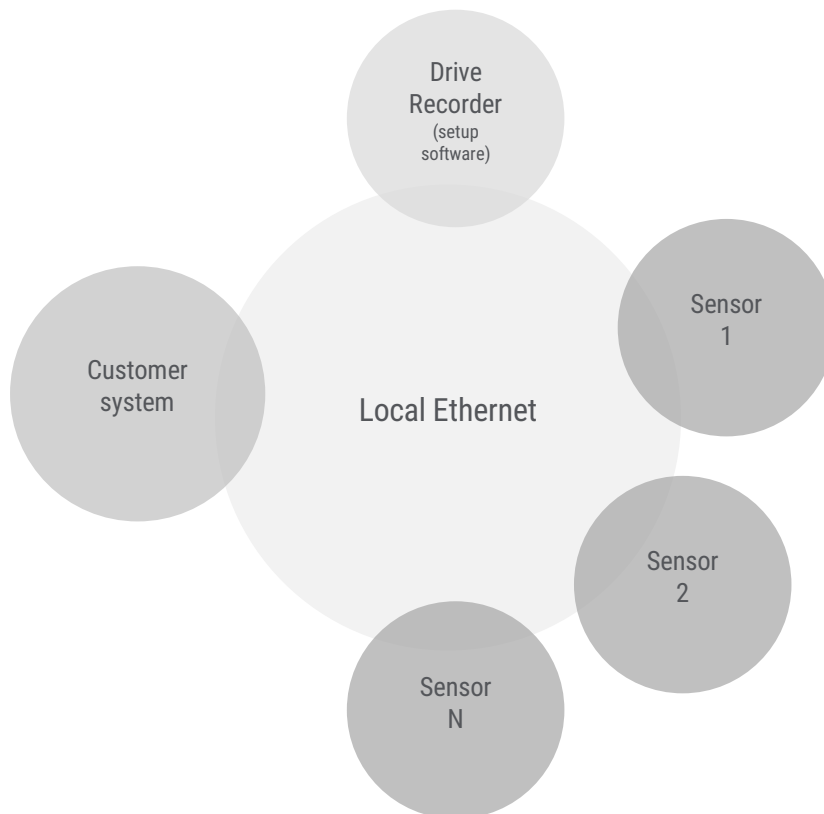

²⁰ Not yet available.

4 APPLICATION-SPECIFIC CHARACTERISTICS

The sensor can be used for long and medium range applications in autonomous driving systems, for example:

- Autonomous driving
- Adaptive Cruise Control (ACC)
- Advanced Emergency Braking (AEB)
- Forward Collision Warning (FCW)
- Rear Collision Warning (RCW)

One or multiple sensors may be integrated into vehicle models. Usually, specific engineering efforts are required for the adaptation to specific vehicle models as well as the application of test and qualification procedures. Customer-specific connectors, CAN FD or Ethernet interfaces, tracking algorithms, warning algorithms or other software packages can be included.

FUNCTIONAL SAFETY

The sensor can optionally be made compliant to ASIL Level B in customer-specific projects. Requirements and safety concepts need to be agreed between a customer and smartmicro.

AUTOSAR

The sensor is offered with AUTOSAR compliant software in customer-specific projects. Specifications need to be agreed between a customer and smartmicro.

HEAVY VEHICLES

The sensor can be used on utility vehicles with operational voltages of 24V (or even up to 32V). It has been tested against the ISO Standard 7637-2.

4.1 POINT CLOUD

Using the point cloud firmware, the sensor can be used for medium- and long-range applications in autonomous driving systems, for example:

- Autonomous driving
- Forward Collision Warning (FCW), AEB, ACC
- Rear Collision Warning (RCW)
- All kinds of 360-degree applications

One or multiple sensors may be integrated into vehicle models. Usually, specific engineering efforts are required for the adaptation to specific vehicle models as well as the application of test and qualification procedures. Customer-specific connectors, CAN(FD) or Ethernet interfaces, tracking algorithms, warning algorithms or other software packages can be included.

4.2 RADAR CUBE STREAMING

The sensor is capable of streaming 2DFFT (radar cube) data if ordered with special software.

For streaming, the Ethernet interface is configured at 1Gbit/s.

5 COMPLIANCES

The sensor model complies with the following EU directives:

- RED 2014/53/EU
- RoHS 2011/65/EU
- EC 1907/2006 REACH

Applied Standards:

- Spectrum Usage:
 - EN 301 091-1 V2.1.1
- EMC:
 - EN 301 489-1 V2.2.0
 - EN 301 489-51 V2.1.0
- Health and Safety:
 - EN 62311: 2008
 - EN 62368-1: 2014 + AC: 2015

Regarding spectrum usage, this sensor model *will be* tested and certified by independent test labs (formally approved by a test lab or notified body):

- EU RED directive
- FCC part 95M
- ISED RSS-251

This sensor model is also generally compliant with the following regional regulations (but may not be formally tested/approved):

- EAC
- SRRC
- KCC
- MIIT
- NCC

Note: This statement of compliance means that the sensor allows operation compliant to the listed standards. However, not all standards are certified through test labs. Formal frequency approval or registration is not accomplished for all countries. In certain countries or regions, a customer-specific local frequency approval is reasonable. smartmicro supports customers throughout this process.

6 LEGAL DISCLAIMER NOTICE

All products, product specifications and data in this document may be subject to change without notice to improve reliability, function or otherwise.

Not all products and/or product features may be available in all countries and regions. For legal reasons features may be deleted from products or smartmicro may refuse to offer products. Statements, technical information and recommendations contained herein are believed to be accurate as of the stated date. smartmicro disclaims any and all liability for any errors, inaccuracies or incompleteness contained in this document or in any other disclosure relating to the product.

To the extent permitted by applicable law, smartmicro disclaims (i) any and all liability arising out of the application or use of the product or the data contained herein, (ii) any and all liability of damages exceeding direct damages, including - without limitation - indirect, consequential or incidental damages, and (iii) any and all implied warranties, including warranties of the suitability of the product for particular purposes.

Statements regarding the suitability of products for certain types of applications are based on smartmicro's knowledge of typical requirements that are often placed on smartmicro products in generic/general applications. Statements about the suitability of products for a particular/specific application, however, are not binding. It is the customer's/user's responsibility to validate that the product with the specifications described is suitable for use in the particular/specific application. Parameters and the performance of products may deviate from statements made herein due to particular/specific applications and/or surroundings. Therefore, it is important that the customer/user has thoroughly tested the products and has understood the performance and limitations of the products before installing them for final applications or before their commercialization. Although products are well optimized to be used for the intended applications stated, it must also be understood by the customer/user that the detection probability may not be 100% and that the false alarm rate may not be zero.

The information provided, relates only to the specifically designated product and may not be applicable when the product is used in combination with other materials or in any process not defined herein. All operating parameters, including typical parameters, must be validated for each application by the customer's/user's technical experts. Customers using or selling smartmicro products for use in an application which is not expressly indicated do so at their own risk.

This document does not expand or otherwise modify smartmicro's terms and conditions of purchase, including but not being limited to the warranty. Except as expressly indicated in writing by smartmicro, the products are not designed for use in medical, life-saving or life-sustaining applications or for any other application in which the failure of the product could result in personal injury or death.

No license, expressed or implied, by estoppel or otherwise, to any intellectual property rights is granted by this document or by any conduct of smartmicro. Product names and markings noted herein may be trademarks of their respective owners.

Please note that the application of the product may be subject to standards or other regulations that may vary from country to country. smartmicro does not guarantee that the use of products in the applications described herein will comply with such regulations in any country. It is the customer's/user's responsibility to ensure that the use and incorporation of products comply with regulatory requirements of their markets.

If any provision of this disclaimer is, or is found to be, void or unenforceable under applicable law, it will not affect the validity or enforceability of the other provisions of this disclaimer.